

Eng Installation guide

D Montageanleitung

F Guide d'installation

E Guía de instalación

NL Installatiehandleiding

N x CL 1 XX M.. series
N x CL 1 XX W..

Le	REF
METRIC 19	N x CL 1 19...
METRIC 22	N x CL 1 22...
METRIC 27	N x CL 1 27...

CAM LOCK CYLINDER

DOOR PROFILE

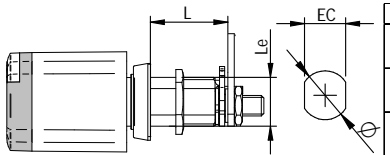

Le	DOOR PROFILE
M19	Ø = 19.1 mm (-3/4") EC ≥ 16.1 mm (-21/32")
M22	Ø = 22.1 mm (-7/8") EC ≥ 17.6 mm (-11/16")
M27	Ø = 27.1 mm (1-1/16") EC ≥ 22.1 mm (-7/8")

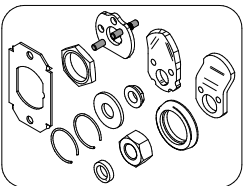

Danger for electronic components due to electrostatic discharge.

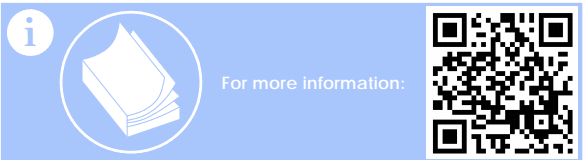
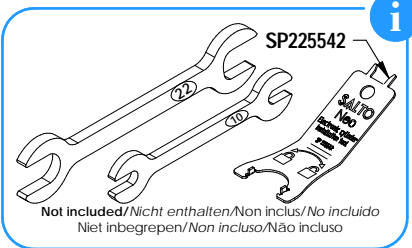

SALTO Neo

© 2023 SALTO Systems S.L. 225776-ED.1- 05/09/2023

All contents current at time of publication. SALTO Systems S.L. reserves the right to change availability of any item in this catalog, its design, construction, and/or materials.

CL

Eng Installation D Montageanleitung F Installation E Instalación NL Montage

1

1.1

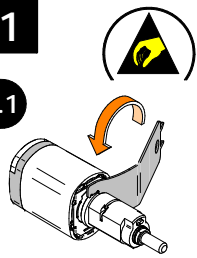

1.2

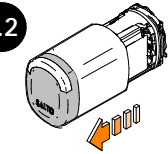

2

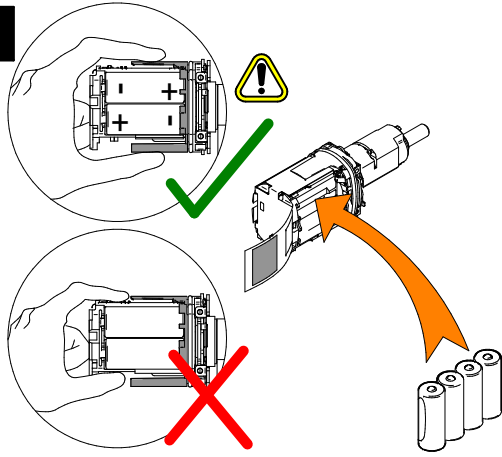

3

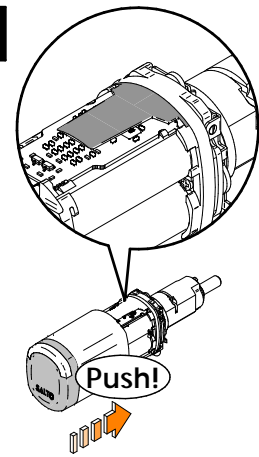

4

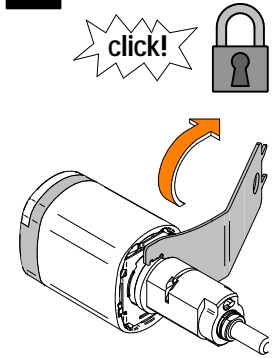

Eng Measure c distance - Select cam type - select components 5a,5b D Gemessene Entfernung c - Auswahl des Hebels - Auswahl der Komponenten 5a, 5b F Mesurer la distance c - Sélection cam - Sélectionner les composants 5a,5b E Medir distancia c - Seleccionar lengüeta - Seleccionar componentes 5a, 5b NL Meet afstand c - Selecteer lip - Selecteer componenten 5a,5b

"C" Door-strike distance				Cam Type and position	Number of spacer washers	Number spacer rings
NxCL119M...	NxCL119W...					
22 to 23mm	57/64"	29 to 30mm	1 - 5/32"	Curved cam	5a	5b
23 to 24mm	59/64"	30 to 31mm	1 - 13/64"		-	2
24 to 25mm	31/32"	31 to 32mm	1 - 15/64"		-	1
25 to 26mm	1"	32 to 33mm	1 - 9/32"		-	-
26 to 27mm	1 - 3/64"	33 to 34mm	1 - 5/16"		1	2
27 to 28mm	1 - 5/64"	34 to 35mm	1 - 23/64"	1	1	
28 to 29mm	1 - 1/8"	35 to 36mm	1 - 25/64"	Straight cam	-	2
29 to 30mm	1 - 5/32"	36 to 37mm	1 - 7/16"		-	1
30 to 31mm	1 - 13/64"	37 to 38mm	1 - 15/32"		-	-
31 to 32mm	1 - 15/64"	38 to 39mm	1 - 33/64"		1	2
32 to 33mm	1 - 9/32"	39 to 40mm	1 - 19/32"		1	1
33 to 34mm	1 - 5/16"	40 to 41mm	1 - 5/16"	Curved cam	1	-
34 to 35mm	1 - 23/64"	41 to 42mm	1 - 41/64"		-	2
35 to 36mm	1 - 25/64"	42 to 43mm	1 - 43/64"		-	1
36 to 37mm	1 - 7/16"	43 to 44mm	1 - 23/32"		-	-
37 to 38mm	1 - 15/32"	44 to 45mm	1 - 3/4"		1	2
38 to 39mm	1 - 33/64"	45 to 46mm	1 - 51/64"	1	1	
39 to 40mm	1 - 19/32"	46 to 47mm	1 - 53/64"	1	-	

Door thickness 15 ≤ t < 15 mm Normally metal doors

Door thickness 15 ≤ t ≤ 22 mm Normally wooden doors

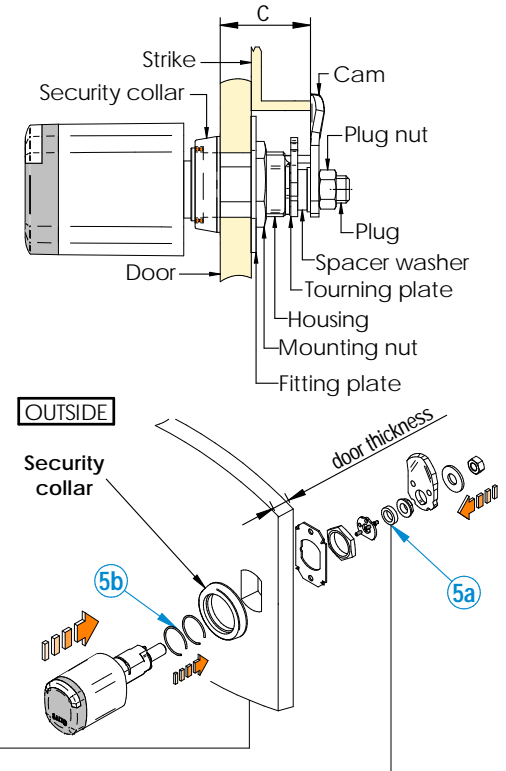

RH+ / LH+

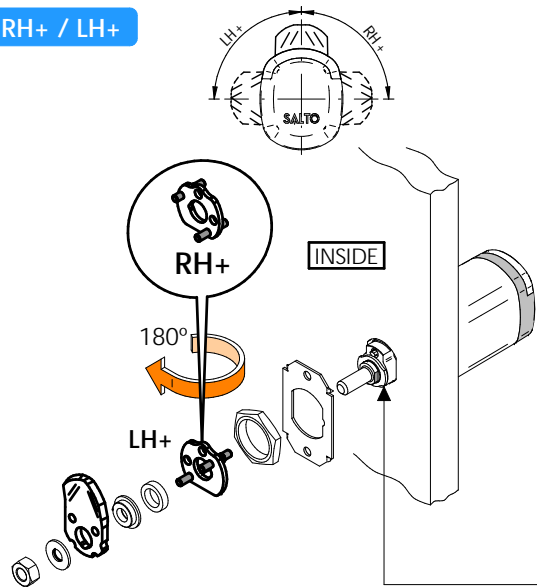

6
SELECT

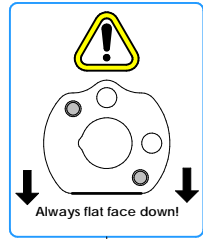

RH- / LH-

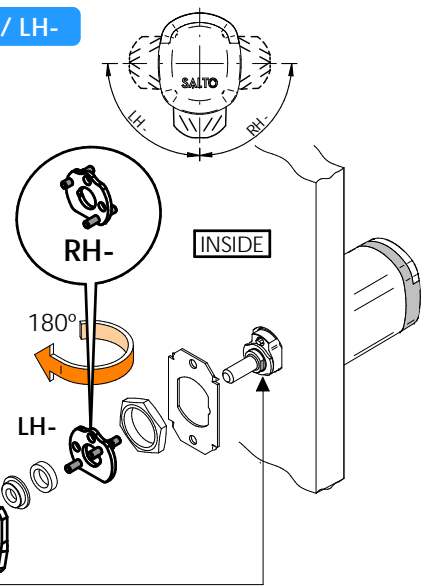

7

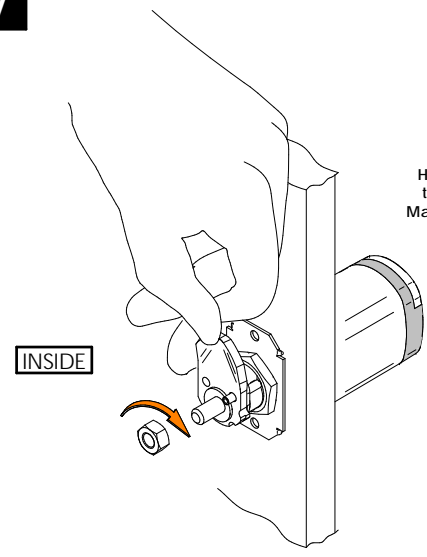

Eng Battery change D Batterie tauchen F Remplacer pile E Sustitución pilas NL Vervangen batterij

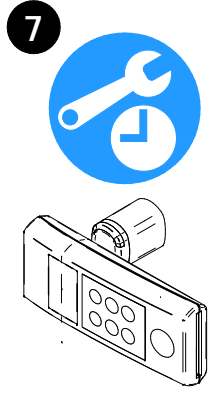
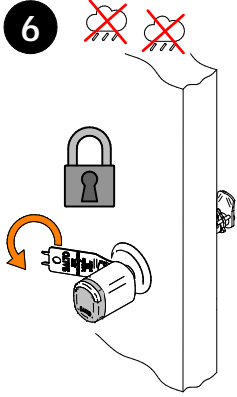
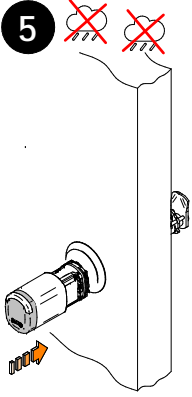
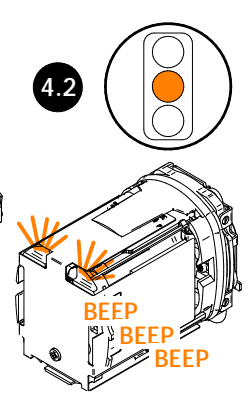
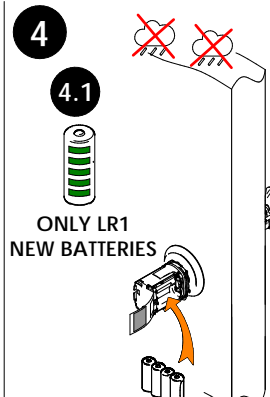
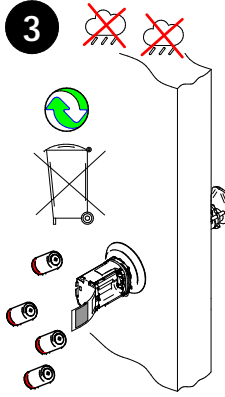
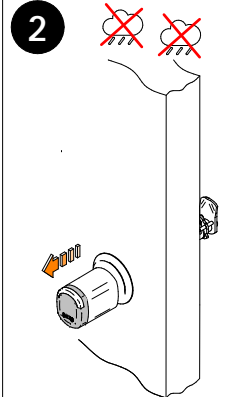
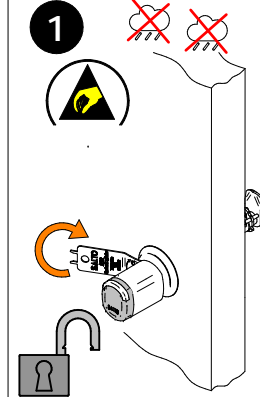
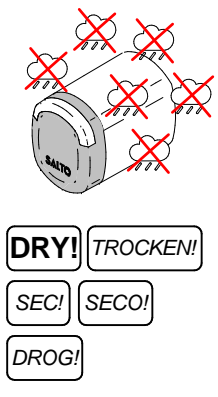

Eng Installation and use recommendations D Empfohlene Handhabung und installation F Recommendations d'utilisation et d'installation E Consejos de uso e instalación NL Aanbevelingen van de gebruik en installatie

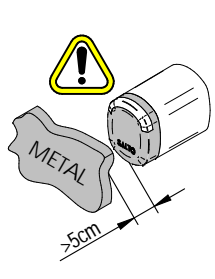
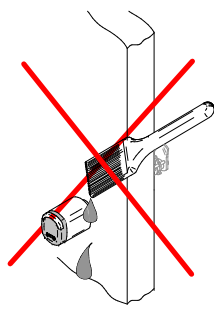
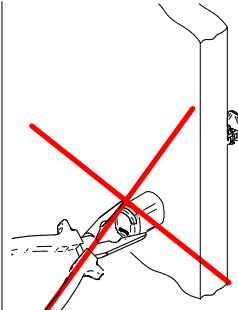
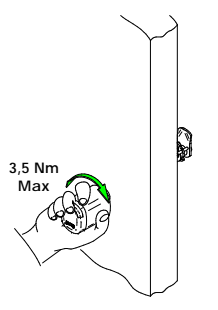

- Eng Do not place any movable metallic object closer than 5cm in front of the reader.
- D Platzieren Sie keine beweglichen Metallteile näher als 5 cm vor dem Leser.
- F Ne placez aucun objet métallique mobile à moins de 5 cm du lecteur.
- E No colocar ningún objeto móvil metálico delante del lector a menos de 5cm de distancia.
- NL Plaats geen enkel beweegbaar metaal voorwerp dichterbij dan 5 cm voor de lezer



- Eng The knob is uniquely paired to the cylinder, and will not work if you switch in a different SALTO cylinder.
 - D Der Knauf ist eindeutig mit dem Zylinder gekoppelt und funktioniert nicht, wenn Sie einen anderen SALTO-Zylinder verwenden.
 - F Le bouton du lecteur SALTO est appairé au cylindre. Le cylindre ne fonctionnera pas si vous l'inverse avec un autre cylindre SALTO.
 - NL El pomo está emparejado únicamente al cilindro, no funcionará si lo conecta a otro cilindro SALTO diferente.
- De knop is uitsluitend gekoppeld aan deze Geo cilinder (getrouwd) en werkt NIET als u een andere SALTO-knop plaatst op deze Geo cilinder.