

WRDx0A4.. series  
WRDx0A4..K series  
WRDx0A4..F series

- Eng Card reader installation guide
- E Guía de instalación lector de tarjetas
- D Kartenleser installationsanleitung
- F Guide d'installation lecteur de cartes
- NL Kaartlezer Installatiehandleiding
- SVE Kortläsare installationsguide

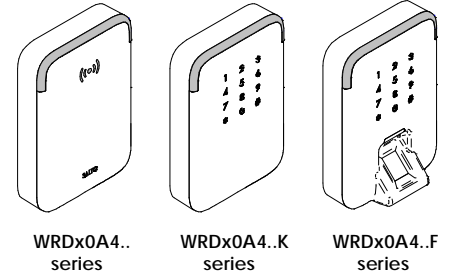

Eng Installation E Instalación D Installation F Installation NL Installatie SVE Installation

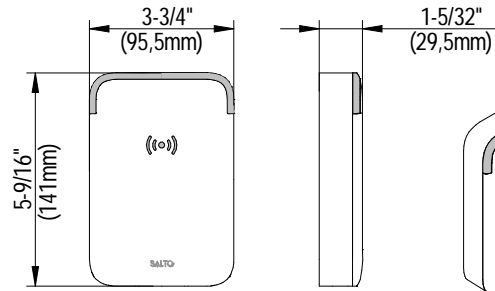
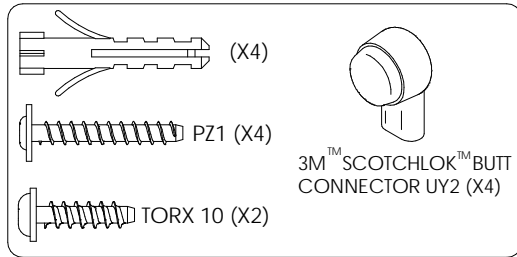
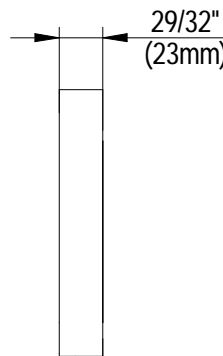
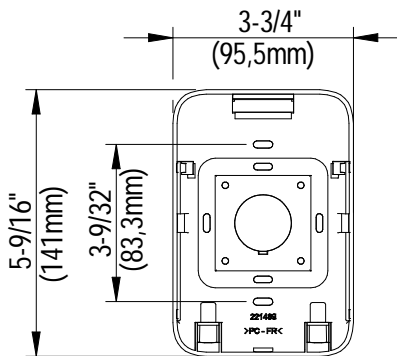
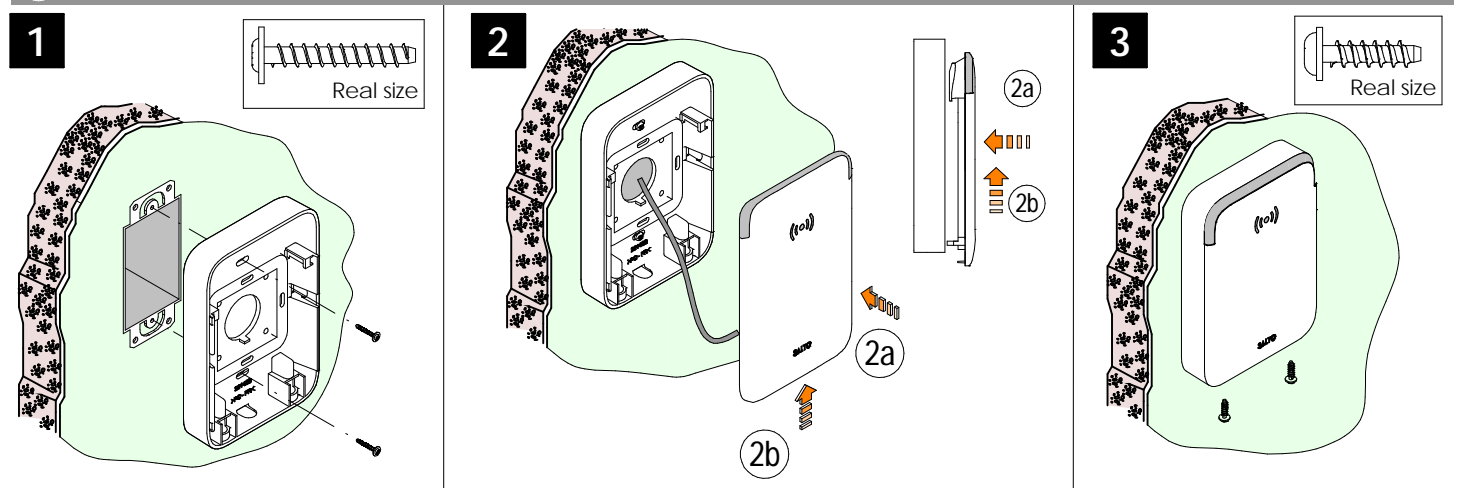

- Eng GANG ELECTRICAL STANDARD BOX
- E MÓDULO CAJA ELÉCTRICA ESTÁNDAR
- D STANDARD SCHALTERDOSE
- F PLOTS D'ENCASTREMENT STANDARD
- NL STANDAARD ELEKTRISCHE INBOUWDOOS
- SVE STANDARD APPARATLADA

Eng Maintenance E Mantenimiento D Instandhouding F Entretien NL Onderhoud SVE Underhåll

- Eng Dampen a lint-free cloth or cotton swap with alcohol. Gently rub the cloth back and forth across the sensor. Repeat the process once or twice as needed. Visually observe that no residual solution remains on the sensor, especially the edges.  
**Caution: Harsh and abrasive materials are not recommended for cleaning sensors.**
- E Humedezca un paño sin pelusa o un algodón con alcohol. Frótelo suavemente de un lado a otro del sensor. Repita el proceso una o dos veces según sea necesario. Comprobar que no queden residuos, especialmente en los bordes.  
**Precaución: No se recomiendan materiales ásperos y abrasivos para limpiar el sensor.**
- D Befeuchten Sie ein fusselfreies Tuch oder einen Wattestäbchen mit Alkohol. Reiben Sie das Tuch vorsichtig über den Sensor hin und her. Wiederholen Sie den Vorgang bei Bedarf ein- bis zweimal. Beobachten Sie optisch, dass keine Restlösung auf dem Sensor verbleibt, insbesondere in den Ecken.  
Vorsicht: Harte und abrasive Materialien werden nicht zur Reinigung des Sensors empfohlen.
- F Humidifiez un chiffon non pelucheux ou un coton-tige avec de l'alcool. Frottez doucement le chiffon d'avant en arrière sur le capteur. Répétez le processus une ou deux fois au besoin. Observez visuellement qu'aucune solution résiduelle ne reste sur le capteur, en particulier les bords.  
**Attention: Les matériaux durs et abrasifs ne sont pas recommandés pour le nettoyage des capteurs.**
- NL Bevochtig een pluisvrije / katoendoek met alcohol. Wrijf de doek voorzichtig heen en weer over de sensor. Controleer visueel of er geen resterende vloeistof op de sensor achterblijft, vooral niet langs de randen van de sensor.  
**Waarschuwing: Harde en schurende materialen worden niet aanbevolen voor het reinigen van de sensoren.**
- SVE Fukta en sluddfri trasa eller bomullsbyte med alkohol. Gnid försiktigt trasan fram och tillbaka över sensorn. Upprepa hela processen fler gånger efter behov, säkerställ att ingen restlösning finns kvar på sensorn, särskilt vid kanterna.  
**Varning: Hårt och slipande material rekommenderas inte för rengöringsensorer.**

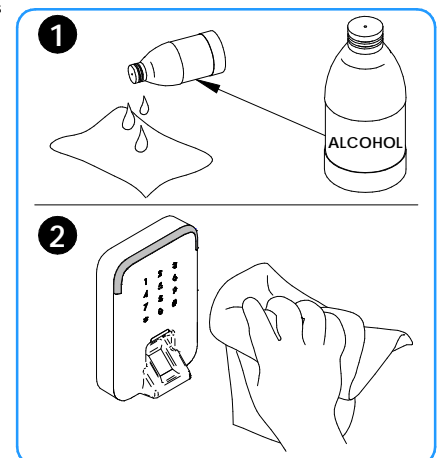

European view ◀ ○

**(Eng)** Electrical characteristics

Operation conditions

	Min.	Max.	Unit
Temperature WRDOB - WRDOS - WRDOBK	-35	+66	°C
Temperature WRDOJ - WRDOGK - WRDOJK	-25	+66	°C
Temperature WRDOBF - WRDOJF	-20	+66	°C
Humidity	35	85	%

RF characteristics

	Min	cen.	Max	Unit
RFID frequency		13.56		Mhz
Bluetooth Smart frequency	2.4	2.445	2.4835	Ghz

**(E)** Características eléctricas

Condiciones ambientales

	Min.	Max.	Unidad
Temperatura WRDOB - WRDOS - WRDOBK	-35	+66	°C
Temperatura WRDOJ - WRDOGK - WRDOJK	-25	+66	°C
Temperatura WRDOBF - WRDOJF	-20	+66	°C
Humedad	35	85	%

Características RF

	Min	cen.	Max	Unit
Frecuencia RFID		13.56		Mhz
Frecuencia Bluetooth Smart	2.4	2.445	2.4835	Ghz

**(D)** Elektronische Eigenschaften:

Umgebungsbedingungen

	Min.	Max.	Einheit
Temperatur WRDOB - WRDOS - WRDOBK	-35	+66	°C
Temperatur WRDOJ - WRDOGK - WRDOJK	-25	+66	°C
Temperatur WRDOBF - WRDOJF	-20	+66	°C
Feuchtigkeit	35	85	%

RF Frequenzen

	Min	Mitte	Max	Einheit
RFID Frequenz		13.56		Mhz
Bluetooth Smart Frequenz	2.4	2.445	2.4835	Ghz

**(F)** Caractéristique électronique

Condition de fonctionnement

	Min.	Max.	Unité
Température WRDOB - WRDOS - WRDOBK	-35	+66	°C
Température WRDOJ - WRDOGK - WRDOJK	-25	+66	°C
Température WRDOBF - WRDOJF	-20	+66	°C
Humidité	35	85	%

Caractéristiques RF

	Min	cen.	Max	Unité
Fréquence RFID		13.56		Mhz
Fréquence Bluetooth Smart	2.4	2.445	2.4835	Ghz

**(NL)** Technische gegevens:

Omgeving

	Min.	Max.	Unit
Temperatuur WRDOB - WRDOS - WRDOBK	-35	+66	°C
Temperatuur WRDOJ - WRDOGK - WRDOJK	-25	+66	°C
Temperatuur WRDOBF - WRDOJF	-20	+66	°C
Vochtigheid	35	85	%

RF karakteristieken

	Min	cen.	Max	Unit
RFID frequency		13.56		Mhz
Bluetooth Smart frequency	2.4	2.445	2.4835	Ghz

**(SVE)** Teknisk data:

Arbetsområde

	Min.	Max.	Enhet
Temperatur WRDOB - WRDOS - WRDOBK	-35	+66	°C
Temperatur WRDOJ - WRDOGK - WRDOJK	-25	+66	°C
Temperatur WRDOBF - WRDOJF	-20	+66	°C
Fukt	35	85	%

RF data

	Min	cen.	Max	Enhet
RFID Frekvens		13.56		Mhz
Bluetooth Smart Frekvens	2.4	2.445	2.4835	Ghz

Power Consumption Note 1

	Min	Max	Unit
Reader		150	mA
Reader+Keyboard		250	mA
Reader+Keyboard+Fingerprint		300	mA

Note 1: Installer must take this data into account to dimension the CU42xx power supply. Readers only for use with the SALTO Control Units.

Note 2: Not use with Scotchlok butt connector UY2 SALTO recommends to use one cable per wall reader.

Consumo Nota 1

	Min	Max	Unit
Lector		150	mA
Lector + teclado		250	mA
Lector+teclado+Fingerprint		300	mA

Note 1: El instalador ha de tener en cuenta la dimensión del alimentador de la CU42xx  
 Nota 2: No usar el conector Scotchlok butt UY2 con este tipo de cable  
 SALTO recomienda utilizar un cable por cada lector mural.

Stromaufnahme Note 1

	Min	Max	Einheit
Leser		150	mA
Leser+Keypad		250	mA
Leser+Keypad+Fingerprint		300	mA

Note 1: Bitte beachten Sie die Stromaufnahme bei der Planung des Netzteils für die CU42XX  
 Note 2: Nicht verwenden mit den Scotchlok Einzeladerverbinder UY2  
 SALTO empfiehlt die Verwendung einer separaten Leitung je Wandleser.

Consommation Note 1

	Min	Max	Unité
Lecteur		150	mA
Lecteur + Clavier		250	mA
Lecteur + Clavier+Fingerprint		300	mA

Note 1: l'installateur doit calculer l'alimentation nécessaire pour alimenter la CU42xx .  
 Note 2: Ne pas utiliser le connecteur Scotchlok UY2 avec ce type de câble  
 SALTO recommande d'utiliser un câble pour chaque lecteur mural

Voeding in opm 1

	Min	Max	Unit
Wandlezer		150	mA
Wandlezer+Keyboard		250	mA
Wandlezer+Keyboard+Fingerprint		300	mA

Opn. 1: Installateur moet deze info meenemen voor de berekening van de voeding voor de CU42xx  
 Opn. 2: 3M Scotchlok 2-voudig draad connectors NIET GEBRUIKEN !!!  
 SALTO adviseert enkel één kabel per wandlezer te gebruiken.

Strömkonsumtion Not 1

	Min	Max	Enhet
Läsare		150	mA
Läsare+Knappsats		250	mA
Läsare+Knappsats+Fingerprint		300	mA

Not. 1: Installatör måste ta med denna information för att beräkna strömmätgång  
 Not. 2: Ej med Scotchlock butt UY2 kontakt  
 SALTO rekommenderar att en kabel per väggläsare används.

Cable type and max. Distances

Cable type	Reader	Reader Keypad	Reader Keypad Fingerprint
UTP Cat5e	328ft	196ft	164ft
2 pairs AWG24	100m	60m	50m
UTP Cat5e	820ft	492ft	328ft
4 pairs AWG24 SP224861/SP224895	250m	150m	100m
Twisted pairs AWG18 Note2	1312ft	918ft	756ft
	400m	280m	200m

Note: UL tested at 24 AWG at 100m.

Tipo de cable y distancias max.

Tipo cable	Lector	Lector Teclado	Lector Teclado Fingerprint
UTP Cat5e	328ft	196ft	164ft
2 pares AWG24	100m	60m	50m
UTP Cat5e	820ft	492ft	328ft
4 pares AWG24 SP224861/SP224895	250m	150m	100m
Pares trenzados AWG18 Nota2	400m	280m	200m

Verkabelung und max. Entfernungen

Kabletyp	Leser	Leser Keypad	Leser Keypad Fingerprint
UTP Cat5e	328ft	196ft	164ft
2 paar AWG24	100m	60m	50m
UTP Cat5e	820ft	492ft	328ft
4 paar AWG24 SP224861/SP224895	250m	150m	100m
Twisted pair AWG18 Note2	400m	280m	200m

Type de câble

Type de câble	Lecteur	Lecteur Clavier	Lecteur Clavier Fingerprint
UTP Cat5e	328ft	196ft	164ft
2 paires AWG24	100m	60m	50m
UTP Cat5e	820ft	492ft	328ft
4 paires AWG24 SP224861/SP224895	250m	150m	100m
Paires torsadées AWG18 Note2	400m	280m	200m

Vermogen en max. Afstand

Kable type	Wandlezer	Wandlezer Keypad	Wandlezer Keypad Fingerprint
UTP Cat5e	328ft	196ft	164ft
2 pairs AWG24	100m	60m	50m
UTP Cat5e	820ft	492ft	328ft
4 pairs AWG24 SP224861/SP224895	250m	150m	100m
Twisted pair AWG18 Opn2	400m	280m	200m

Kabletyper och max avstånd

Kabel	Läsare	Läsare Knappsats	Läsare Knappsats Fingerprint
UTP Cat5e	328ft	196ft	164ft
2 pairs AWG24	100m	60m	50m
UTP Cat5e	820ft	492ft	328ft
4 pairs AWG24 SP224861/SP224895	250m	150m	100m
Twisted pair AWG18 Not 2	400m	280m	200m

- Ⓔ **Installation example:**
- Ⓔ *Ejemplo de instalación:*
- Ⓔ *Installationsbeispiel:*
- Ⓔ *Exemple d'installation:*
- Ⓔ *Installatievoorbeeld:*
- Ⓔ *Installationsexempel:*

- Ⓔ **Only connect to CU42xx**
- Ⓔ *Solo conectar a CU42xx*
- Ⓔ *Nur für Steuereinheit CU42xx*
- Ⓔ *Connecter uniquement CU42xx*
- Ⓔ *Alleen aansluiten aan CU42xx*
- Ⓔ *Ansluts endast till CU42xx*

- Ⓔ **Cable connection**
- Ⓔ *Câblage*
- Ⓔ *Cableado*
- Ⓔ *Draadwerk*
- Ⓔ *Verdrahtung*
- Ⓔ *Ledningar*

	Eng	Esp	Fra	Deu	Ned	Sve
B	Green	Verde	Vert	Grün	Groen	Grön
A	Yellow	Amarillo	Jaune	Gelb	Geel	Gul
⊥	Black	Negro	Noir	Schwarz	Zwart	Svart
+V	Red	Rojo	Rouge	Rot	Rood	Röd

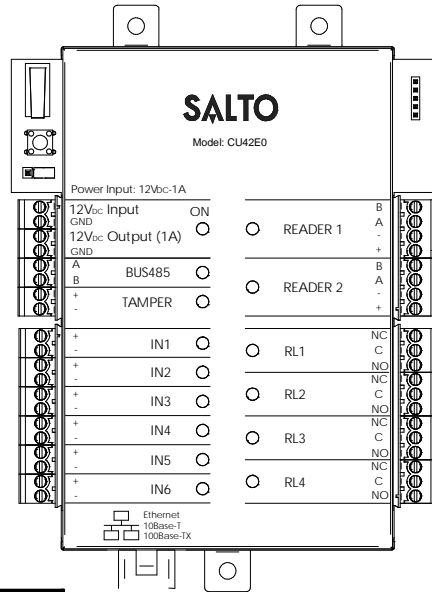

- Ⓔ **Same pair**
- Ⓔ *Même paire*
- Ⓔ *Mismo par*
- Ⓔ *Gleiches Paar*
- Ⓔ *Hetzelfde paar*
- Ⓔ *Samma par*

- Ⓔ **3M™ Scotchlok™ butt connector UY2. Crimp with cap side down.**
- Ⓔ *Conector 3M™ Scotchlok™ butt UY2. Crimpar con la tapa hacia abajo.*
- Ⓔ *3M™ Scotchlok™ butt Einzeladerverbinder UY2. Mit der Kappe nach unten zusammendrücken.*
- Ⓔ *Connecteur 3M™ Scotchlok™ butt UY2. Crêper avec le capuchon vers le bas.*
- Ⓔ *3M™ Scotchlok™ draad connectors - UY2. Krimp/aanknijpen met het gekleurde deksel naar beneden.*
- Ⓔ *3M™ kontakt Scotchlok™ butt UY2. Monteras med platta sidan neråt.*

- Ⓔ **Installation example with RJ45:**
- Ⓔ *Ejemplo de instalación RJ45:*
- Ⓔ *Innstillationsbeispiel für RJ45:*

- Ⓔ *Exemple d'installation avec connecteur RJ45 :*
- Ⓔ *Installatie voorbeeld RJ45:*
- Ⓔ *Installationsexempel RJ45:*

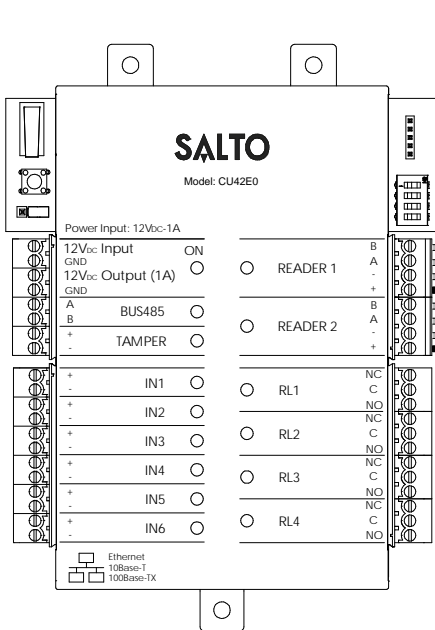

- Ⓔ **Optional**
- Ⓔ *Opcional*
- Ⓔ *Optioneel*
- Ⓔ *Optionnelle*
- Ⓔ *Facultatief*
- Ⓔ *Valfritt*

- Ⓔ **Black**
- Ⓔ *Negro*
- Ⓔ *Schwarz*
- Ⓔ *Noir*
- Ⓔ *Zwart*
- Ⓔ *Svart*

- Ⓔ **Optional**
- Ⓔ *Opcional*
- Ⓔ *Optioneel*
- Ⓔ *Optionnelle*
- Ⓔ *Facultatief*
- Ⓔ *Valfritt*

- Ⓔ **Red**
- Ⓔ *Rojo*
- Ⓔ *Rot*
- Ⓔ *Rouge*
- Ⓔ *Rood*
- Ⓔ *Röd*

- Ⓔ **Minimum distance between readers 20in (50cm).**
- Ⓔ *Distancia mínima entre los lectores 20in (50cm).*
- Ⓔ *Mindestabstand zwischen Lesern 20in (50cm).*
- Ⓔ *Distance minimale entre les lecteurs doit être de 20in (50cm).*
- Ⓔ *Minimale afstand tussen de lezers 20in (50cm).*
- Ⓔ *Minsta avstånd mellan läsare 20in (50cm).*

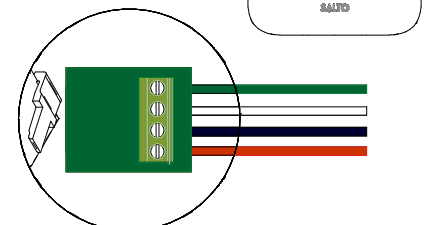
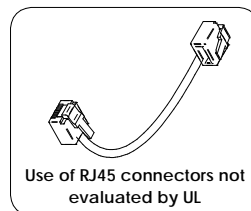

SIGNAL	LIGHT	TIME	BUZZER	TIME
Card / finger rejection	Red	1sec	High pitched 50/50	1sec
Privacy or emergency status	Red 5x(50/50x3 + off 300)	3sec	High pitched 5x(50/50x3 +off 300)	3sec
Standard opening	Green	1sec	Low pitched	0,3sec
Standard locking	Red	0,5sec	Low pitched	0,2sec
Open plus office	Green 400/200	2,4sec	High pitched/Low pitched 400/200	2,4sec
CLR Button	Orange	Cont.	High pitched	Cont.
Reset	Orange 50/100	450msc	Low pitched 50/100	450msc
Waiting for card / finger	Blinking green 500/500	Cont.	Low pitched 500/500	Cont.
Card / finger processing	Blinking yellow 50/50	100msc	Low pitched 50/50	100 msec
Successfully processed card / finger	Green	1sec	Low pitched	1 sec
SEÑAL	LUZ	TIEMPO	BUZZER	TIEMPO
Rechazo de tarjeta / huella	Rojo	1seg	Agudo 50/50	1seg
Rechazo por privacidad o emergencia	Rojo 5x(50/50x3 + apagado 300)	3seg	Agudo 5x(50/50x3 + apagado 300)	3seg
Apertura normal	Verde	1seg	Medio	0,3seg
Cierre normal	Rojo	0,5seg	Grave	0,2seg
Abrir y paso	Verde 400/200	2,4seg	Agudo/Grave400/200	2,4seg
Botón CLR (3)	Naranja	Cont.	Agudo	Cont.
Reset	Naranja 50/100	450mseg	Medio 50/100	450mseg
Espera de tarjeta / huella	Verde intermitente 500/500	Cont.	Grave intermitente 500/500	Cont.
Procesado de tarjeta / huella	Amarillo intermitente 50/50	100 msec	Grave intermitente 50/50	100 msec
Tarjeta / huella procesada con éxito	Verde	1 seg	Medio	1 seg
SIGNAL	LED	ZEIT	BUZZER	ZEIT
Medium / Finger abgelehnt	Rot	1sek	Hoher Ton 50/50	1sek
Bitte-nicht-stören oder Notschließung	Rot 5x(50/50x3 + aus 300)	3sek	Hoher Ton 5x(50/50x3 + aus 300)	3sek
Normale Türöffnung	Grün	1sek	Tiefer Ton	0,3sek
Verschluss de Tür	Rot	0,5sek	Tiefer Ton	0,2sek
Office-Mode aktiviert	Grün 400/200	2,4sek	Hoher Ton/Grave400/200	2,4sek
CLR Taste gedrückt	Orange	Kont.	Hoher Ton	Cont.
Reset	Orange 50/100	450msk	Tiefer Ton 50/100	450msk
Warte auf Medium / Finger	Grün blinken 500/500	Konst.	Tiefer Ton 500/500	Konst.
Medium / Fingerverarbeitung	Gelb blinken 50/50	100msk	Tiefer Ton 50/50	100msk
Medium / Finger erfolgreich verarbeitet	Grün	1sek	Tiefer Ton	1sek
SIGNAL	VOYANT	TEMP	BUZZER	TEMP
Carte / Empreinte rejeté	Rouge	1sec	Aigur 50/50	1sec
Privacité ou état d'urgence	Rouge 5x(50/50x3 + off 300)	3sec	Aigu 5x(50/50x3 + off 300)	3sec
Ouverture standard	Vert	1sec	Grave	0,3sec
Verrouillage standard	Rouge	0,5sec	Grave	0,2sec
Ouverture passage libre	Vert 400/200	2,4sec	Aigu/Grave400/200	2,4sec
Bouton CLR	Orange	Cont.	Aigu	Cont.
Reset	Orange 50/100	450msc	Grave 50/100	450msc
En attente de a carte / du doigt	Vert clignotant 500/500	Cont.	Aigur 500/500	Cont.
Traitement de la carte / du doigt	Jaune clignotant	100ms	Aigu 50/50	100ms
Carte / doigt validée avec succès	Vert	1sec	Grave	1sec
SIGNAAL	LED INDICATE	TIME	GELUID	TIME
Kaart/vinger weigering	Rood	1sec	Hoge tonen 50/50	1sec
Privacy-of boodsluiting	Rood 5x(50/50x3 + off 300)	3sec	Hoge tonen 5x(50/50x3 + off 300)	3sec
Standaard opening	Groen	1sec	Lage tonen	0,3sec
Standaard sluiting	Rood	0,5sec	Lage tonen	0,2sec
Open plus loopstand	Groen 400/200	2,4sec	Hoge tonen/Grave400/200	2,4sec
CLR knop	Oranje	Cont.	Hoge tonen	Cont.
Reset	Oansje 50/100	450msc	Lage tonen 50/100	450msc
Wachten op kaart/vinger	Blinkar grön 500/500	Konst.	Låg ton 500/500	Konst.
Kaart/vinger in behandeling	Blinkar gult 50/50	100ms	Låg ton 50/50	100ms
Opening kaart/vinger	Grön	1sek	Låg ton	1sek
HÄNDELSE	LJUSSIGNAL	TID	SUMMER	TID
Kort / Fingeravtryck nekat	Röd	1 sek	Hög ton 50/50	1sek
Stör ej eller Nödläge	Röd 5x(50/50x3 + av 300)	3sek	Hög ton 5x(50/50x3 + av 300)	3sek
Standard öppning	Grön	1sek	Låg ton	0,3sek
Standard stänging	Röd	0,5sek	Låg ton	0,2sek
Öppning med kontorsfunktion	Grön 400/200	2,4sek	Hög ton/Låg tone 400/200	2,4sek
CLR Knapp	Orange	Konst.	Hög ton	Konst.
Nollställning	Orange 50/100	450ms	Låg ton 50/100	450msk
Väntar på kort / finger	Blinkar grön 500/500	Konst.	Låg ton 500/500	Konst.
Kort / Finger processas	Blinkar gult 50/50	100ms	Låg ton 50 /50	100ms

## UL Statements

Tested by UL with Mifare (DESFIRE, ULTRALIGHT C) and HID iCLASS RFID communication, and with Mobile APP (Justin Mivile version 2.x) through Bluetooth version 4.2. Minimum Operating System version for Android: 4.3 or later and for iOS: 10.0 or later. A means of verification shall be employed by the user to enable access to the wireless electronic device such as a PIN or biometric feature. The wireless electronic device is not capable of command, control, programming, or any other system manipulation and it is only to be used in the same manner as a physical credential. Wiring methods that shall be in accordance with the National Electrical Code, ANSI/NFPA 70 or CSA C22.1-02 - Canadian Electrical Code, Part 1, Safety Standard for Electrical Installations

### - UL294 performance level:

FEATURE	LEVEL
Destructive attack	I
Line Security	I
Endurance	IV
Standby power	Per rating of the power supply

### - Comply with ULC-S319 Class I

This device complies with Industry Canada license-exempt RSS standard(s). Operation is subject to the following two conditions: (1) this device may not cause harmful interference, and (2) this device must accept any interference received, including interference that may cause undesired operation. Changes or modifications not expressly approved by the party responsible for compliance could void the user's authority to operate the equipment.

*Le présent appareil est conforme aux CNR d'Industrie Canada applicables aux appareils radio exempts de licence. L'exploitation est autorisée aux deux conditions suivantes: (1) l'appareil ne doit pas produire de brouillage, (2) l'utilisateur de l'appareil doit accepter tout brouillage radioélectrique subi, même si le brouillage est susceptible d'en compromettre le fonctionnement.*

This device has been tested and found to comply with the limits for a Class B digital device, pursuant to ICES-003.

European view 

(\* Note: WRD0GK, WRD0S, WRD0BFand WRD0JF models, not UL listed.